

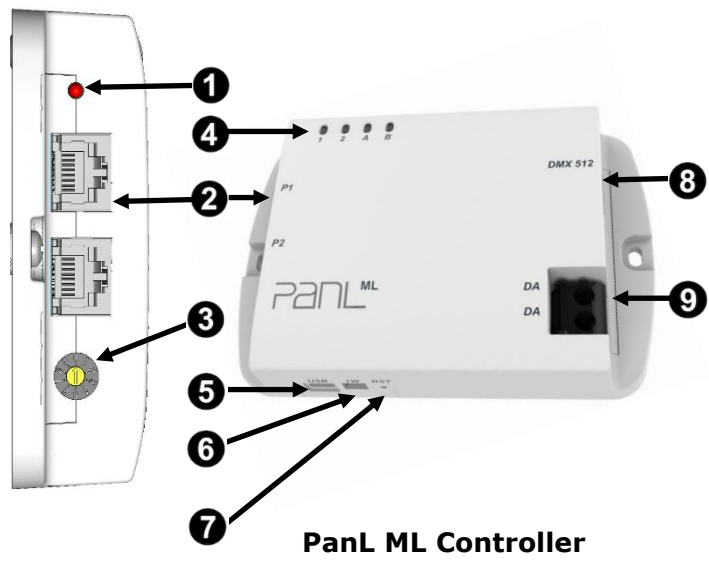

STICKER AREA

PanL PC0011 Mood Lighting (ML) DALI/DMX 512 Controller Quick Start Guide

Product Features



PanL ML Controller

- 1 Power Indicator
- 2 RJ45 Ports – Connect to PanL PH44/80 Hub, another PanL Device or Terminator
- 3 ID Switch – Refer to the [ID Switch Configuration](#) section for more details
- 4 LED Status Indicator - Refer to the [DALI/DMX ML Controller LED Status Indicator](#) section for more details
- 5 USB – Reserved for factory use only
- 6 SWD – Reserved for factory use only
- 7 Reset Button
- 8 DMX Connection – Refer to the [PanL DMX Setup](#)
- 9 DALI Connection – Refer to the [PanL DALI Setup](#)

PanL ML Controller Setup

1. To securely mount the device on a flat surface, M4 screws and nuts can be applied at the slots at the side of the enclosure. (Not provided in the box)
2. If connecting multiple ML Controllers to the same PanL Hub port in a daisy chain configuration, set the ID switch. Refer to the section - [ID Switch Configuration](#) for details.
3. Connect RJ45 cable and add a terminator. Refer to the section [PanL Hub Connection](#) for details.
4. If using **DMX**, refer to [PanL DMX Setup](#) for details.
5. If using **DALI**, refer to [PanL DALI Setup](#) for details.

PanL Hub Connection

The PanL ML Controller is designed to be connected to a PanL Hub for power and data via the P1 or P2 RJ45 ports. When a single PanL ML Controller is connected to a PanL Hub port, the maximum length of the RJ45 cable shall not exceed 100 meters. Connect the terminator (provided in the PanL Hub package) to the unconnected P1 or P2 port.

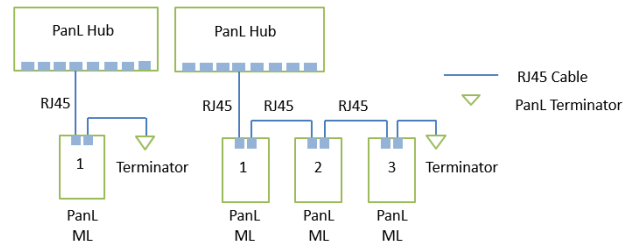

For multiple PanL ML Controller connections to a single PanL Hub port, the first connection to PanL Hub and the subsequent connections in between the PanL ML Controller devices must not exceed 50 meters in cable length, each. The total combined cable lengths must not exceed 100 meters. Connect the terminator provided in PanL Hub box to the last unconnected PanL ML Controller P1 or P2 port.

ID Switch Configuration

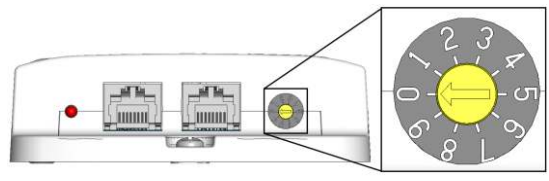

For multiple PanL ML Controller connections to a single PanL Hub port, the ID switch must be configured to be unique. Using a Philip head screw driver, set a unique number for each device between 0-7 (do not use 8-9). For example, if connecting 3 PanL ML Controllers to a PanL Hub port, you may set it as 0, 1, and 2. PanL ML Controllers connected to different PanL Hub ports can share the same unique number.

PanL DMX Setup

Connect a RJ45 cable from the PanL ML Controller port labelled DMX 512 to the first DMX decoder and connect a DMX terminator to the last unused decoder port as illustrated in the example below. The PanL ML Controller supports up to 512 DMX channels. Depending on the number of channel(s) per decoder used, the cumulative channels must not exceed 512 for all connected decoders. Please refer to the Decoder's datasheet for any cable length specifications.

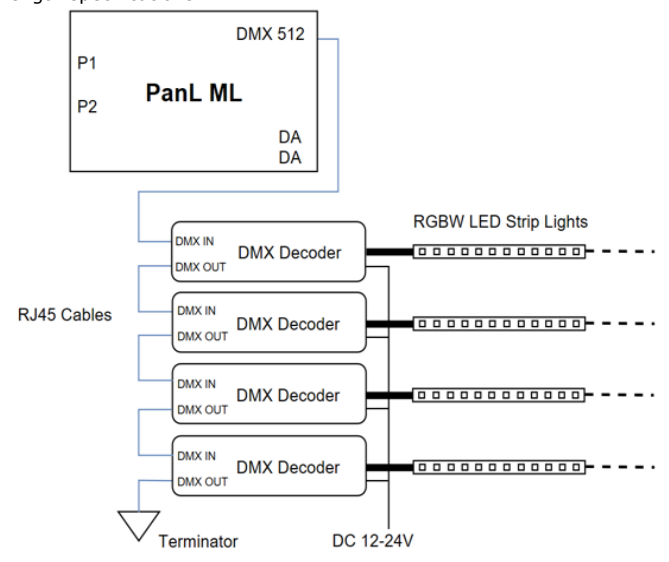





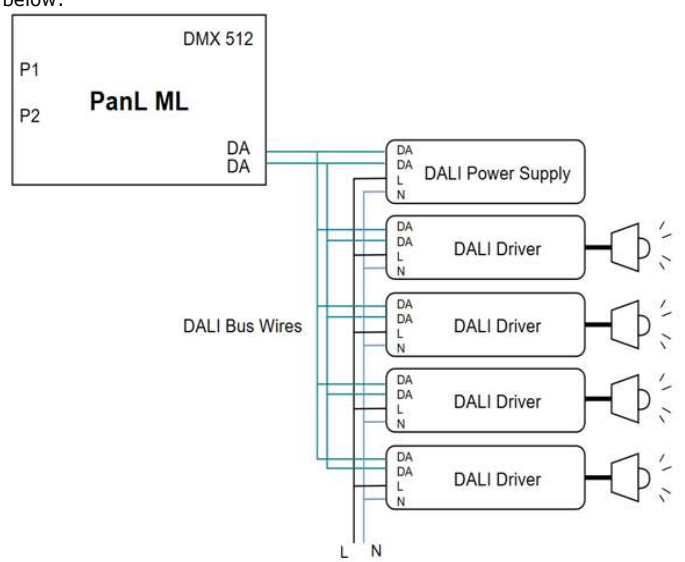



















































PanL DALI Setup

Connect the DALI bus wires to the two DA terminals on PanL ML Controller and tighten the screws for a secure connection. The DALI bus is polarity free and so the two wires may be connected to either port. The recommended maximum length of the bus is 300 meters when AWG16 standard 2core wire in single cable or cable conduit is used. PanL ML Controller supports up to 64 DALI drivers. An external DALI bus power supply is required as illustrated below:



DALI / DMX ML Controller LED Status Indicator

Normal Function Status	System Status (1)		Communications (2)		DALI Status (A)		DMX Status (B)	
Power On Status	Red		Red		Red		Red	
Boot Success	Green		Red		Off		Off	
No Communication	Green		Red		Off		Off	
Communication	Green		Green*		Off		Off	
DALI Data Transfer	Green		Green*		Green*		Off	
DMX Data Transfer	Green		Green*		Off		Green*	
Discover in Progress	Green		Green*		Green		Off	

Failsafe Status	System Status (1)		Communications (2)		DALI Status (A)		DMX Status (B)	
Power On Status	Red**		Off		Off		Off	
Boot Success	Red**		Off		Off		Off	
No Communication	Red**		Red		Off		Off	
Communication	Off		Green*		Off		Off	
Waiting for Recovery	Red<->Green**		Green*		Off		Off	
Discover in Progress	Red<->Yellow**		Green*		Off		Off	
Recovery Done	Green**		Green**		Off		Off	

* - LED blinks during data transfer
** - LED blinks twice a second (2Hz rate)